

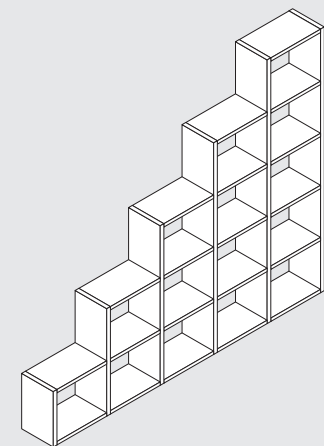

studimo

Specifications
Spezifikationen
Spécifications
Technische gegevens

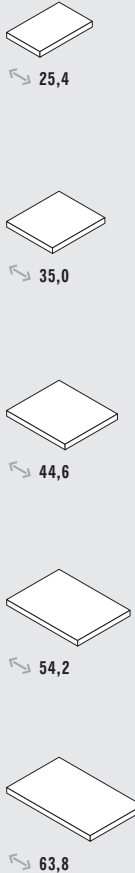

Depths Tiefen Profondeurs Diepten	Widths Breiten Largeurs Breedten	Heights Höhen Hauteurs Hoogten	Variety of combinations Kombinationsvielfalt Diversité de combinaisons Combinatiemogelijkheden
 <p>25,4 35,0 44,6 54,2 63,8</p>	 <p>40,0 50,0 69,7 83,3 103,3 142,7</p>	 <p>40,3 76,3 112,3 148,3 184,3 220,2 256,2 292,2</p>	 <p>3,3</p> <ul style="list-style-type: none"> All shelf walls have a drilling grid of 12 cm as standard. Customised drilling grids are possible. The walls can be stacked in order to obtain even more height. Combinations in depth are possible flush front or flush back. Furthermore, special sizes are possible. All depths, widths and heights can be adjusted accurately to the millimetre. <ul style="list-style-type: none"> Alle Regalseiten haben Standard ein Bohrraster von 12 cm. Individuelle Bohrraster möglich. Die Regalseiten können aufeinander gestapelt werden, um so noch mehr Höhe zu erreichen. Tiefenversprünge sind front- oder rückwandbündig möglich. Darüber hinaus sind auch Sonderanfertigungen möglich. Alle Tiefen, Breiten und Höhen können millimetergenau angepasst werden. <ul style="list-style-type: none"> Tous les montants de rayonnage sont munis de percements standard espacés de 12 cm. Possibilité de percements individuels. Les montants peuvent être superposés afin d'obtenir encore plus de hauteur. Combinaisons en profondeur sont possibles avec alignement de façade ou de fond. De plus, des fabrications spéciales sont aussi possibles. Toutes les profondeurs, largeurs et hauteurs peuvent être adaptées précisément au millimètre. <ul style="list-style-type: none"> Alle kastzijden zijn standaard uitgerust met een doorlopend boorraster van 12 cm. Individuele boorrasters mogelijk. Alle kastzijden kunnen op elkaar gestapeld worden om nog meer hoogte te kunnen bereiken. Combinaties in de diepte zijn front- of achterwandgelijk mogelijk. Daarenboven is speciaal maatwerk mogelijk. Alle diepten, breedten en hoogten kunnen op één millimeter precies aangepast worden.

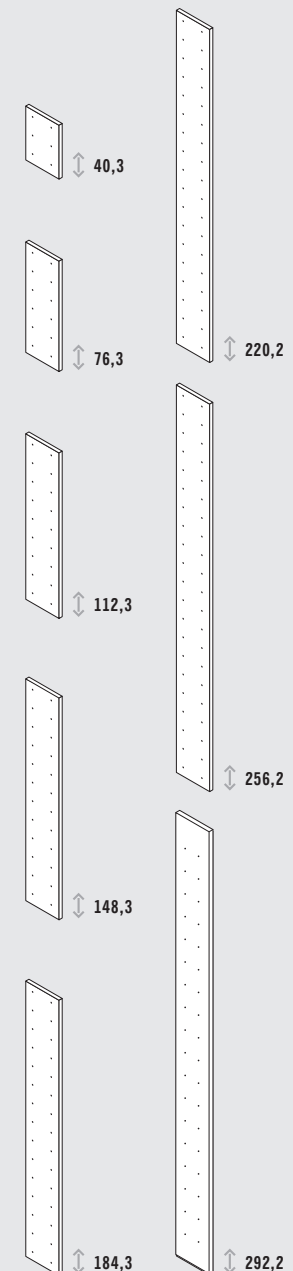
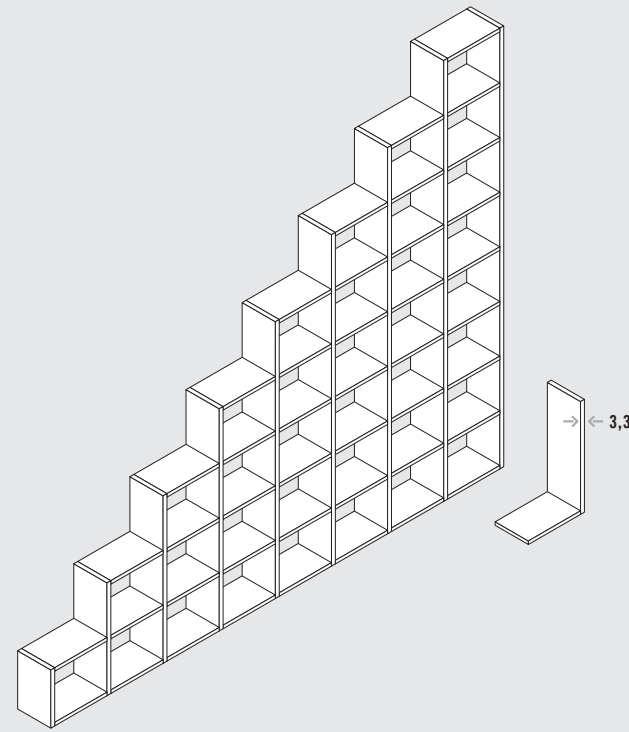
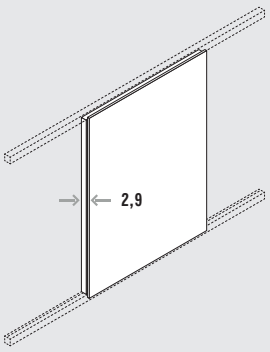
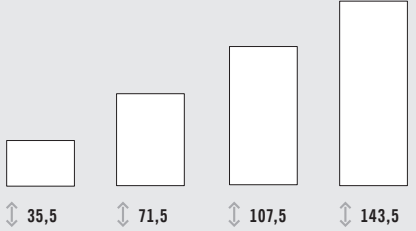
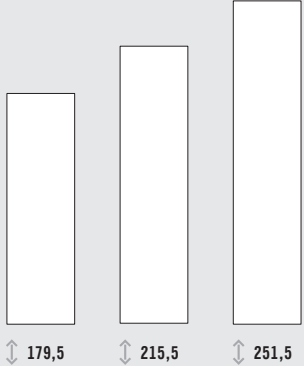
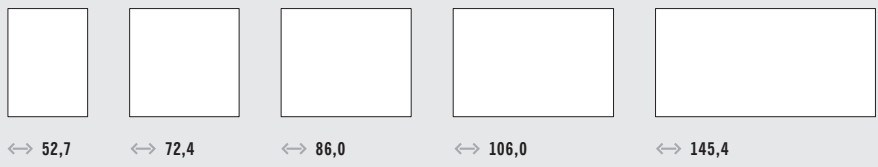
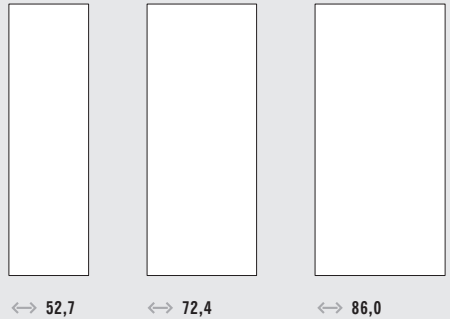
Thickness Stärke Épaisseur Dikte	Heights Höhen Hauteurs Hoogten	Widths Breiten Largeurs Breedten
 <p>→ ← 2,9</p>	 <p>↕ 35,5 ↕ 71,5 ↕ 107,5 ↕ 143,5</p>  <p>↕ 179,5 ↕ 215,5 ↕ 251,5</p> <p>The height of 251.5 cm is only possible for widths of 52.7 and 72.4 cm</p> <p>Die Höhe 251,5 cm ist nur für Breite 52,7 und 72,4 cm möglich</p> <p>La hauteur de 251,5 cm n'est disponible que pour les largeurs de 52,7 et 72,4 cm</p> <p>De hoogte 251,5 cm is uitsluitend mogelijk voor de breedten 52,7 en 72,4 cm</p>	 <p>↔ 52,7 ↔ 72,4 ↔ 86,0 ↔ 106,0 ↔ 145,4</p>  <p>↔ 52,7 ↔ 72,4 ↔ 86,0</p>

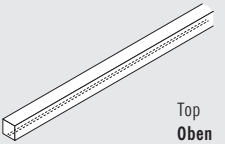
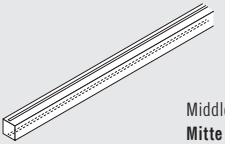
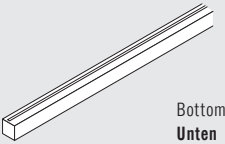
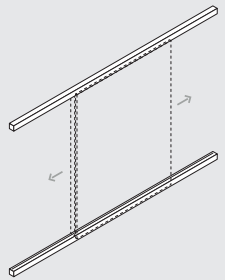
Width Breite Largeur Breedte	Technique Mechanik Technique Techniek
 <p>Top Oben Haut Boven</p>  <p>Middle Mitte Milieu Midden</p>  <p>Bottom Unten Bas Onder</p> <p>↔ max. 550,0</p>	

Thickness **Stärke** Épaisseur Dikte

Heights **Höhen** Hauteurs Hoogten

Widths **Breiten** Largeurs Breedten

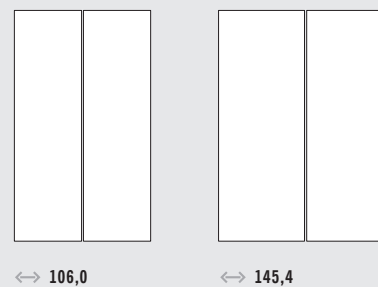
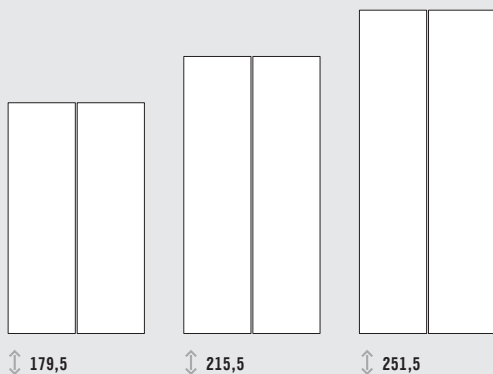
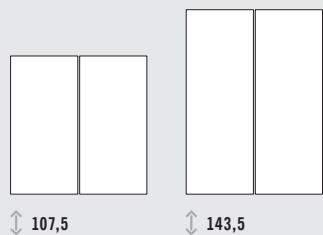
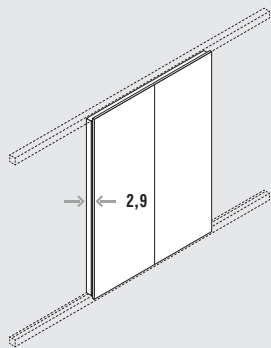

Running track in lacquer **Laufschiene in Lack** Rail de roulement en laque Looprail in lak

Width **Breite** Largeur Breedte

Technique **Mechanik** Technique Techniek

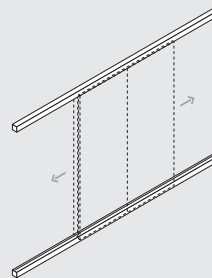
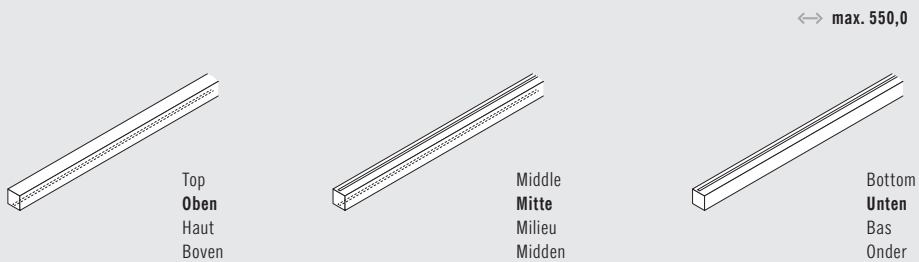

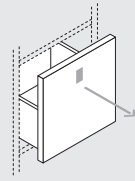
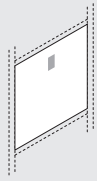

With folding handle
Mit Klappgriff
Avec poignée escamotable
Met klapgreepje

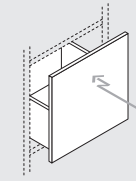

With push-to-open function
Mit Push-to-open-Technik
Avec système d'ouverture par pression
Met push-to-open-functie

For shelf element width **Für Regalbreite** Pour largeur d'élément Voor elementbreedte

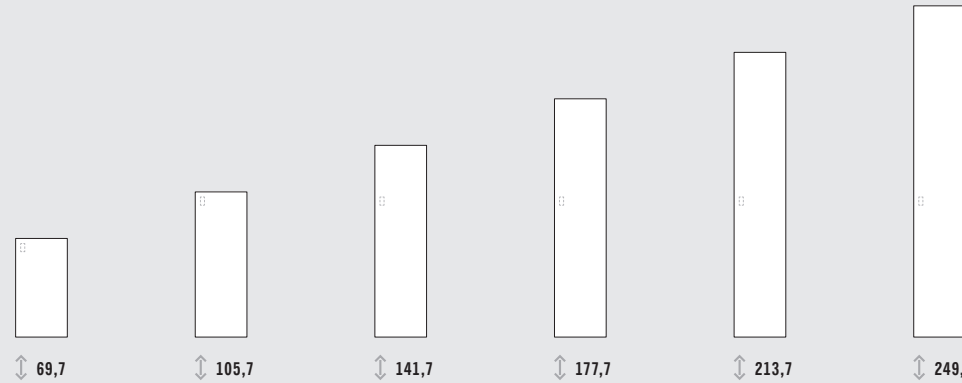
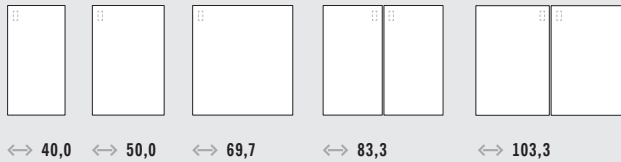

For shelf element depth **Für Regaltiefe** Pour profondeur d'élément Voor elementdiepte

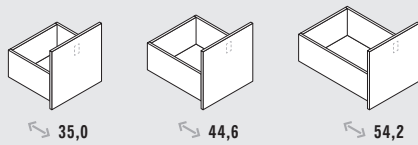

For shelf element width **Für Regalbreite** Pour largeur d'élément Voor elementbreedte

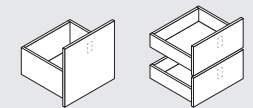

For shelf element width **Für Regalbreite** Pour largeur d'élément Voor elementbreedte

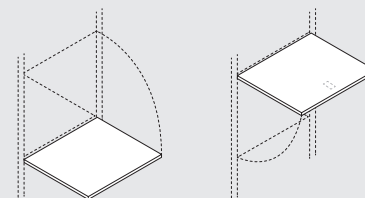

Ladder **Leiter** Échelle Ladder

Heights **Höhen** Hauteurs Hoogten

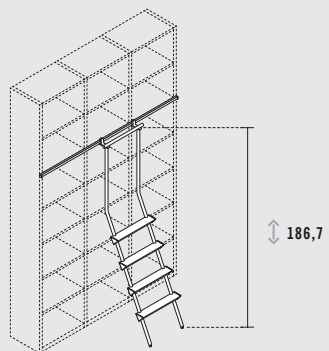

Width **Breite** Largeur Breedte

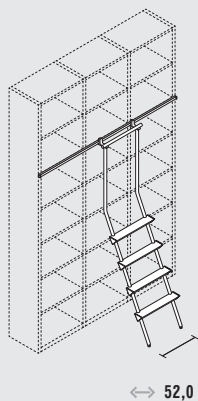

Depths **Tiefen** Profondeurs Diepten

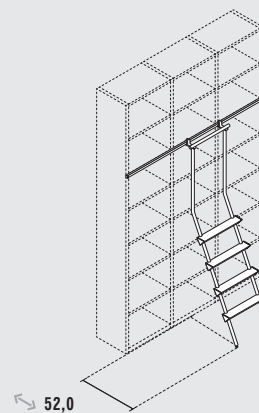

Steps **Stufen** Marches Treden

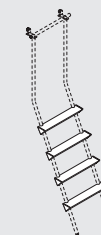

4 Steps **Stufen** Marches Treden

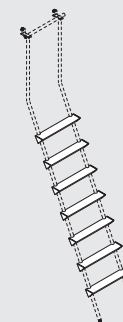
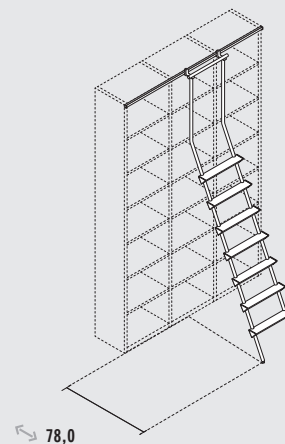
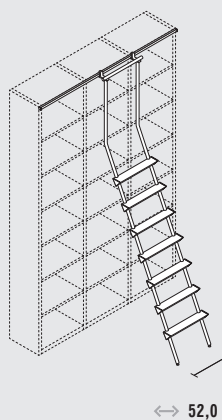
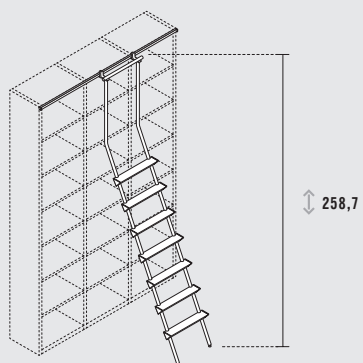

7 Steps **Stufen** Marches Treden

Rail **Schiene** Rail Rail

Width **Breite** Largeur Breedte

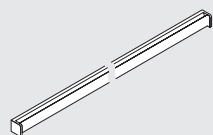

↔ max. 550,0



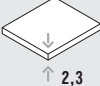
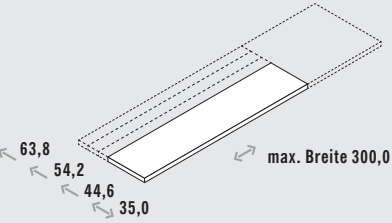
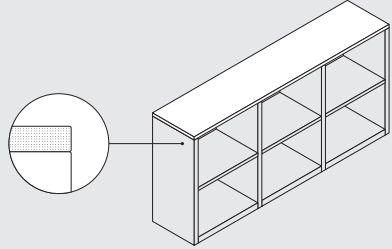
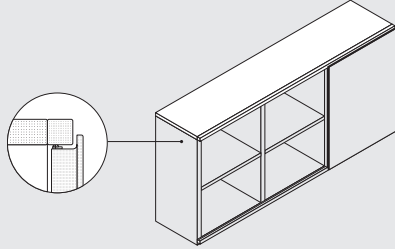



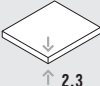
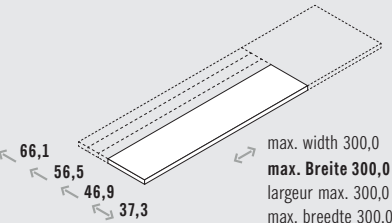
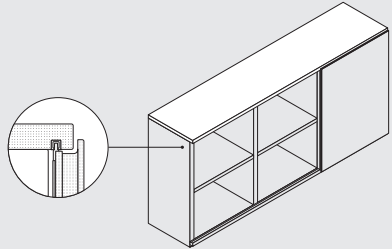

Top-closing panels **Abdeckplatten** Plateaux supérieurs Afdekbladen

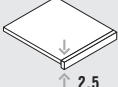
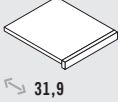
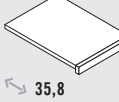
Thickness Stärke Épaisseur Dikte	Depths/Widths Tiefen / Breiten Profondeurs/Largeurs Diepten/Breedten	Detail Detail Détail Detail	Variant with gliding door Variante mit Schiebetür Modèle à porte coulissante Variant met schuifdeur
 <p>↑ 2,3</p>	 <p>63,8 54,2 44,6 35,0 max. Breite 300,0</p>		

Top closing panels with inserted top running track **Abdeckplatten mit eingefräster oberer Laufschiene** Plateaux supérieurs avec rail de roulement supérieur encastré Afdekbladen met ingefreesde bovenste looprail

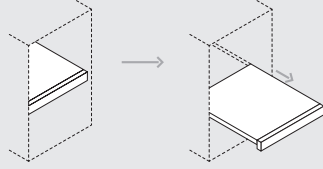
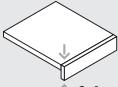
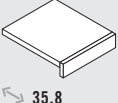
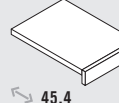
Thickness Stärke Épaisseur Dikte	Depths/Widths Tiefen / Breiten Profondeurs/Largeurs Diepten/Breedten	Detail Detail Détail Detail
 <p>↑ 2,3</p>	 <p>66,1 56,5 46,9 37,3 max. width 300,0 max. Breite 300,0 largeur max. 300,0 max. breedte 300,0</p>	

Pull-out shelves **Auszugböden** Tablettes coulissantes Uittreklanken

Thickness Stärke Épaisseur Dikte	Depths Tiefen Profondeurs Diepten	Widths Breiten Largeurs Breedten	Technique Mechanik Technique Techniek
 <p>↑ 2,5</p> <p>Max. carrying capacity 18 kg Max. Traglast 18 kg Charge max. 18 kg Max. belasting 18 kg</p>	 <p>↔ 31,9</p>  <p>↔ 35,8</p>	 <p>↔ 40,0</p>  <p>↔ 50,0</p>  <p>↔ 69,7</p>	
 <p>↑ 6,4</p> <p>Max. carrying capacity 60 kg Max. Traglast 60 kg Charge max. 60 kg Max. belasting 60 kg</p>	 <p>↔ 35,8</p>  <p>↔ 45,4</p>	 <p>↔ 50,0</p>  <p>↔ 69,7</p>  <p>↔ 83,3</p>  <p>↔ 103,3</p>	

Depths **Tiefen**
Profondeurs Diepten

Widths **Breiten**
Largeurs Breedten

Heights **Höhen**
Hauteurs Hoogten

Sub-/Superstructure **Unter-/Überbau**
Construction inf./supérieure Onder-/Bovenbouw

Versions **Varianten**
Variantes Varianten

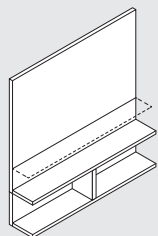

↔ 35,0



↔ 83,3

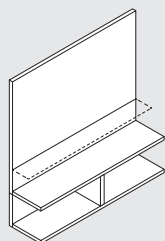

↔ 44,6

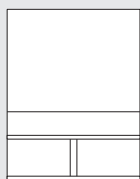

↔ 103,3

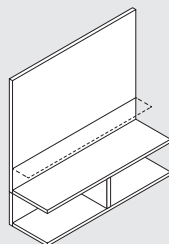

↔ 54,2

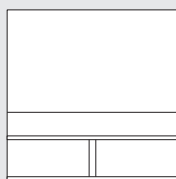

↔ 142,7



105,7

87,7

17,2

40,2

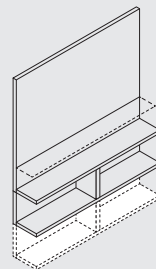

↕ 145,9 (+ 40,2)

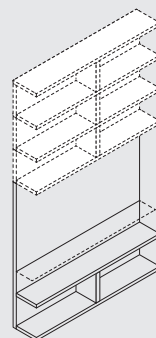

↕ 145,9 (+ 38,5) (+ 74,5) (+ 110,5)

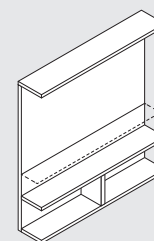

Open
Offen
Ouvert
Offen

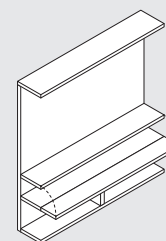

Open with flap
Offen mit Klappe
Ouvert avec abattant
Open met klep

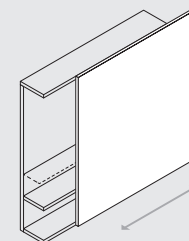

With gliding door
Mit Schiebetür
Avec porte coulissante
Met schuifdeur

Depths Tiefen Profondeurs Diepten	Width/Heights Breite/Höhen Largeur/Hauteurs Breedte/Hoogten	Versions Varianten Variantes Varianten				Sub-/Superstructure Unter-/Überbau Construction inf./supérieure Onder-/Bovenbouw	Swivel doors Schwenktüren Portes à débattement Zwenkdeuren
		Standard	Standard	Standard	Standaard		

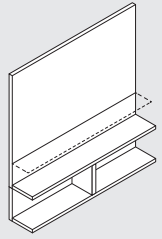
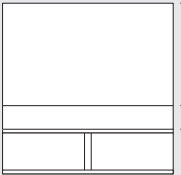
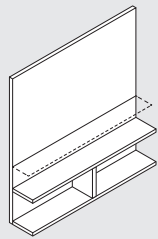
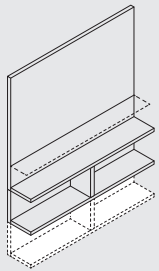
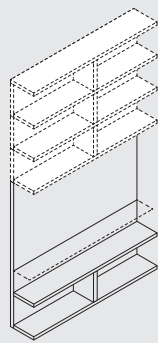
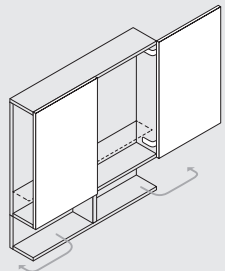
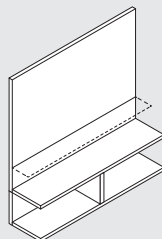
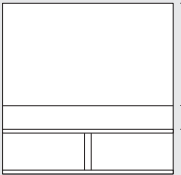
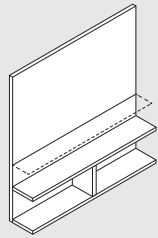
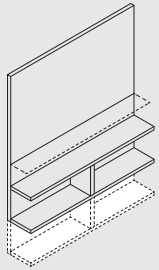
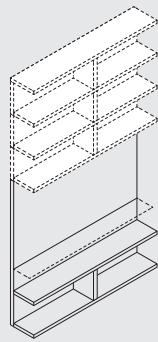
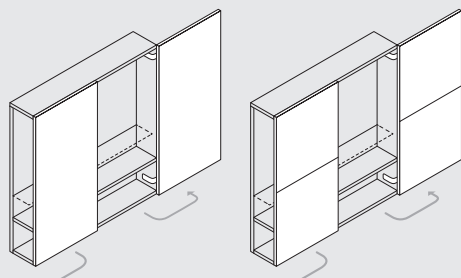
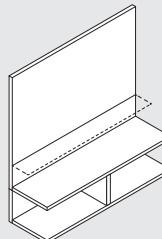
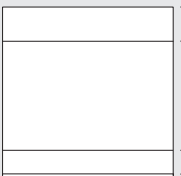
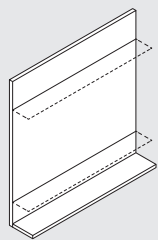
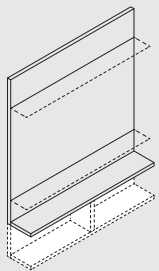
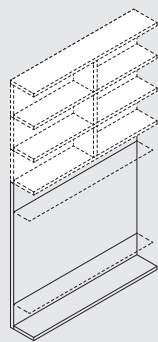
 <p>↔ 35,0</p>	 <p>↔ 142,7</p>	 <p>↕ 145,9</p>	 <p>↕ 145,9 (+40,2)</p>	 <p>↕ 145,9 (+38,5) (+74,5) (+110,5)</p>	
 <p>↔ 44,6</p>	 <p>↔ 142,7</p>	 <p>↕ 145,9</p>	 <p>↕ 145,9 (+40,2)</p>	 <p>↕ 145,9 (+38,5) (+74,5) (+110,5)</p>	
 <p>↔ 54,2</p>	 <p>↔ 142,7</p>	 <p>↕ 141,7</p>	 <p>↕ 141,7 (+40,2)</p>	 <p>↕ 141,7 (+38,5) (+74,5) (+110,5)</p>	